



Nordic Geo Support

Dilation & Joint Sealing Alternatives

About us



- Originating from the Nordics with leading edge technical solutions for global customers.
- We specialise in innovative products with an emphasis on improving sustainability for mining, tunnelling and construction industries.
- Partnering with leading technology companies globally for improving our world's future.
- Nord Geo Support and its partners are focusing on bringing the production of technology closer to customer, reducing the global CO₂ footprint and reliance on global supply chains.

Reducing Project Impacts

Sustainability & Environmental: Solutions that drastically reduce CO₂ emissions in manufacture and transport and energy usage as well as offering longer life cycles and reusability.

Asset Optimisation & Productivity: Solutions that are faster, more efficient, easier to use and reusable, optimising advance rates and ore recovery as well as reducing maintenance costs.

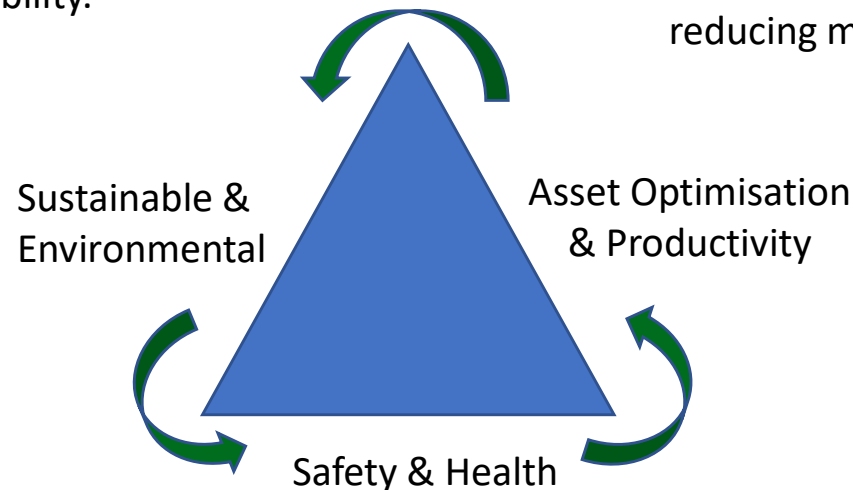

Safety & Health: Solutions that remove humans and equipment from unsecured ground, faster ground securing, ensuring stability and consolidation, reduce manual operations and weight in manual handling.

Product range

Drilling Consumables

High Performance rock drilling tools and consumables:

- DTH Hammers
- Bits
- Shanks
- Rods
- Drill Pipes
- Adapters
- Augers, Accessories

Injection Grouts

Leading edge resin injection technology for demanding cases:

- Water Stopping
- Sealing
- Ground Consolidation
- Ground Stabilisation
- Construction and structural repairs

Anchoring & Bolting Grouts

Grouting technologies offering ease of use, clean and fast setting:

- Capsules
- Cartridges
- Pumpable grouts
- Additives

Anchoring & Bolting

A broad range of rock bolting and anchoring technologies:

- Double and single coated protected steel
- Steel Self Drilling Anchors
- GFRP bolrs of all types
- Standard bolts and meshes

Cement-Based Additives

Cement based admixtures and additives:

- Concrete Repair
- Admixtures
- Modifiers
- Waterproofing
- Joint Sealants

Pumps & Accessories

Cement and resin mixing and pumping technologies:

- Cement Pumps
- Resin Pumps
- Transfer systems
- Dataloggers
- Hoses, lances, packers

Water control

Waterproofing, drainage and pumping:

- TunnelDrain innovative strip drainage system
- Drainage pipes
- Waterproofing grouts, additives and sealants
- A broad range of dewatering pumps

Ventilation

Air quality, ventilation and safety solutions:

- Ventilation bags and systems, including Mecanicad's rigid ducts
- Fans & inline coolers
- Water atomisers

Re-usable Hangers

Developed in the Nordics, fast, easy to use & reuse:

- Services Hooks for ventilation systems, water and pneumatic lines, electrical cables and distribution boards
- Blasting hooks

Other products

A range of other products:

- Coatings & sealants
- Personal protective products
- Mining accessories

Dilatation Joint Sealing

Classical cross section

Positioning of PROOFMATE Waterstop PVC „AD“ Werksnorm and formwork

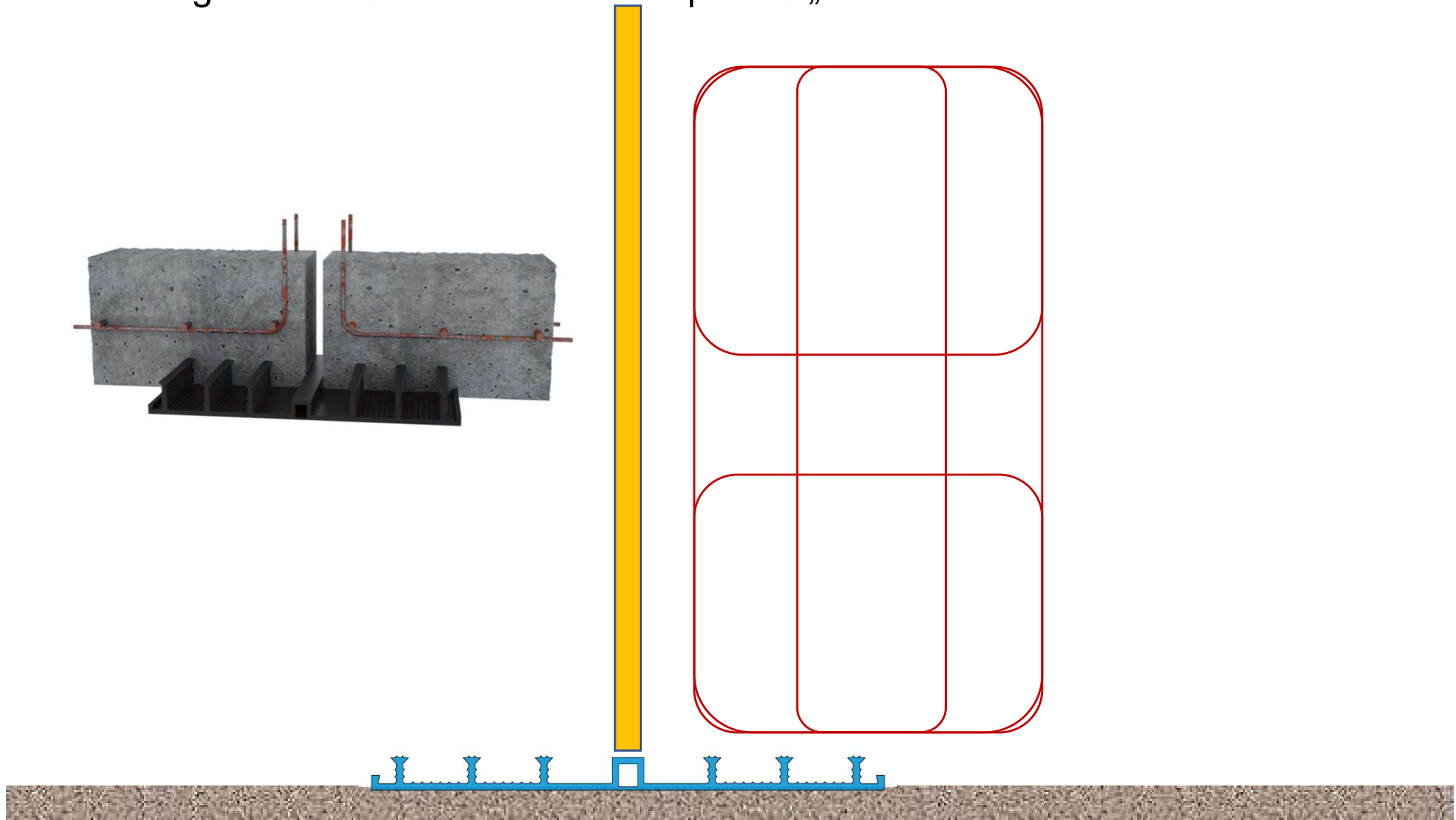

Dilatation Joint Sealing

Classical cross section

Pour of concrete

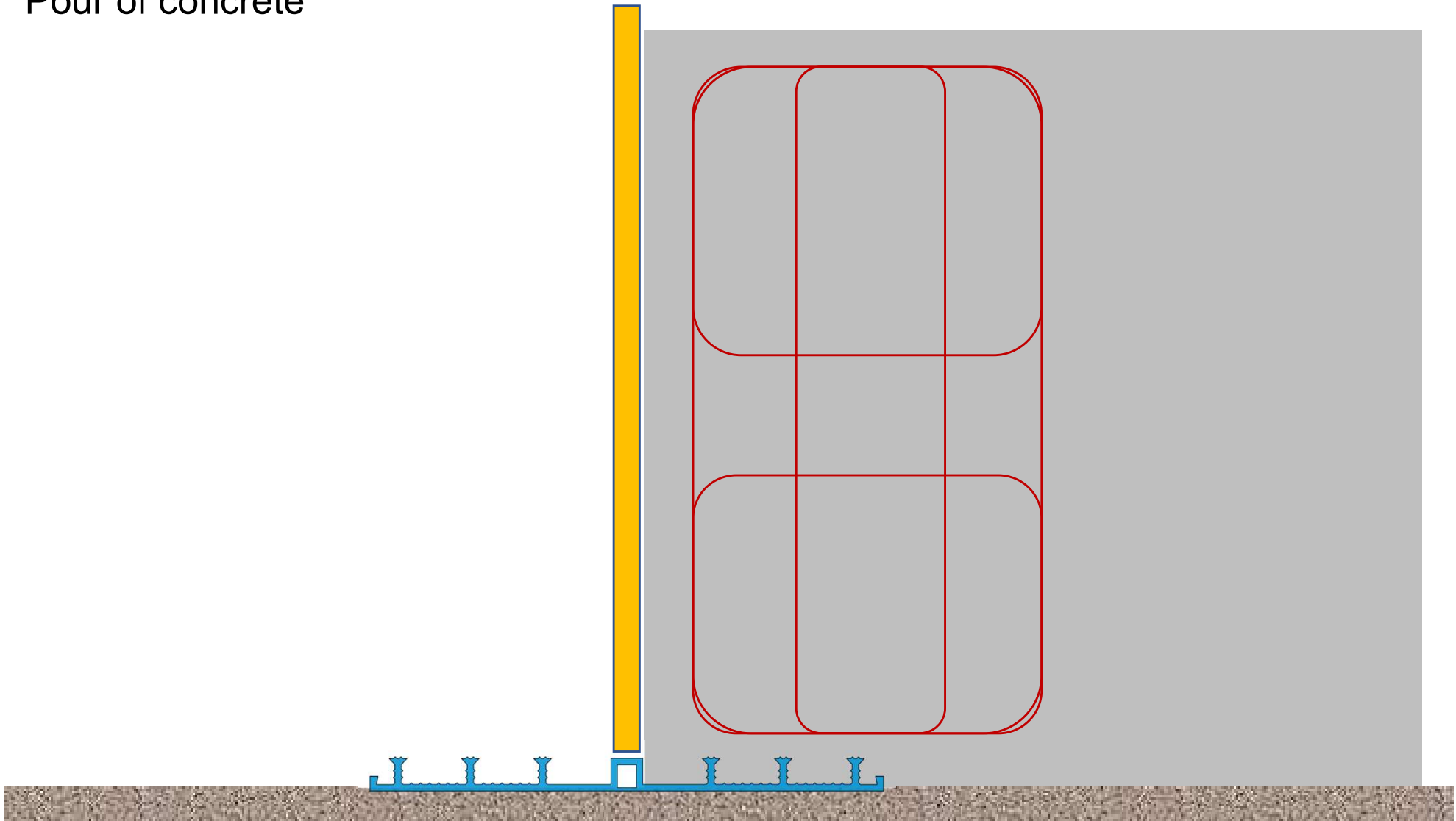

Dilatation Joint Sealing

Classical cross section

Placement of filler board, reinforcement and successive pour

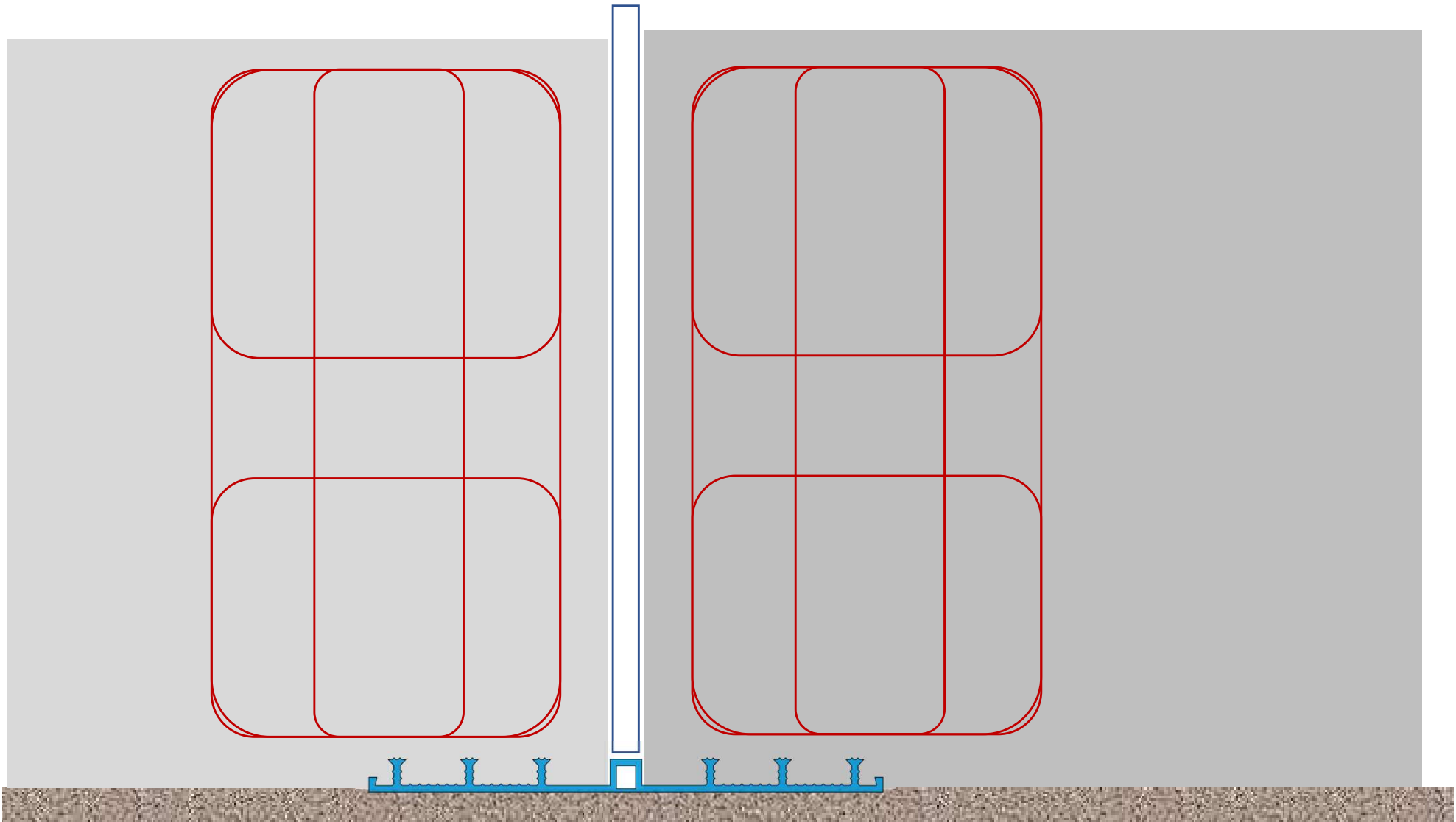

Dilatation Joint Sealing

Classical cross section

Removal of formworks, positioning of Hydroseal profile and Injection hose

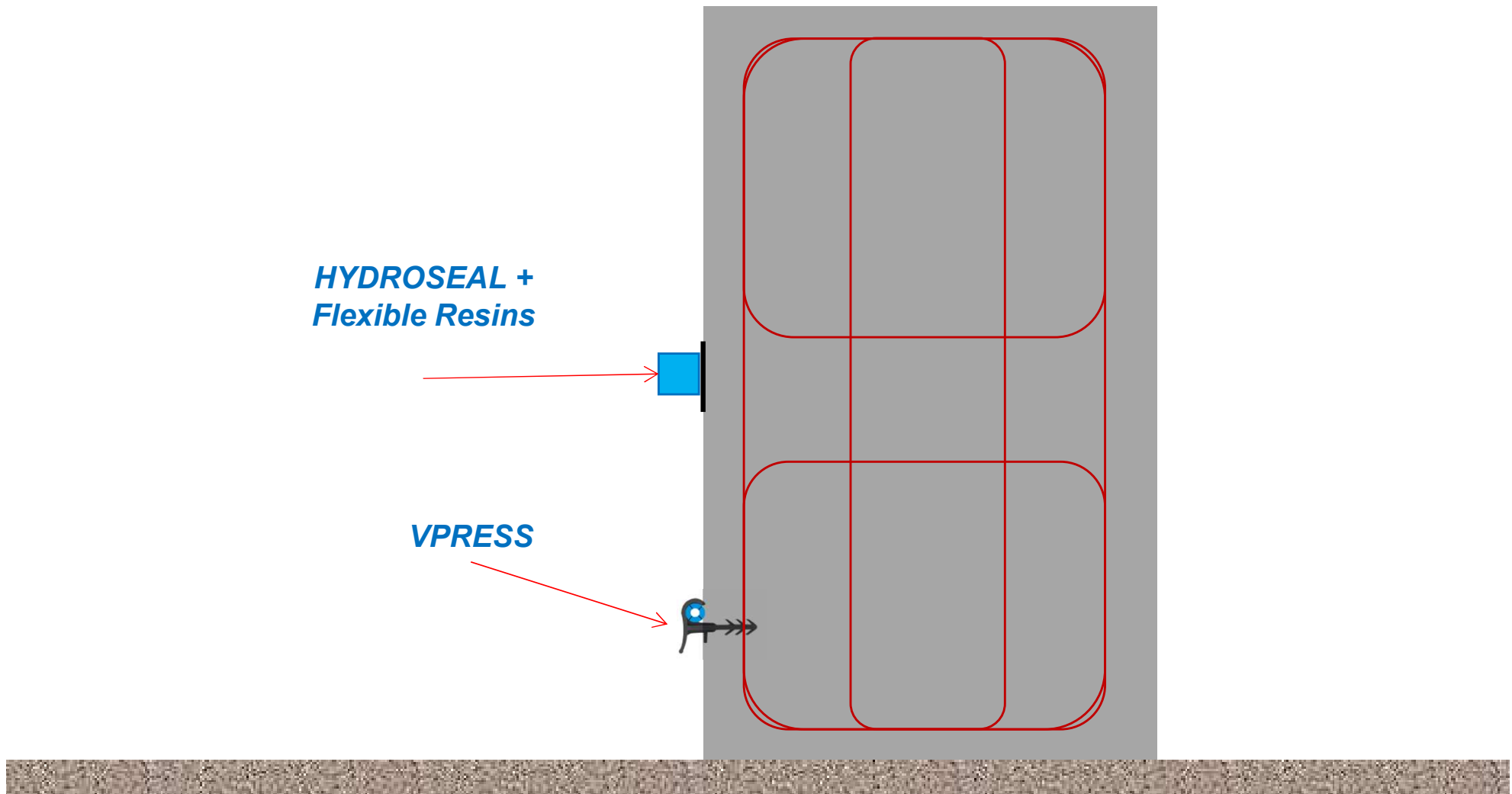

Dilatation Joint Sealing

Classical cross section

Placement of filler board, reinforcement and successive pour

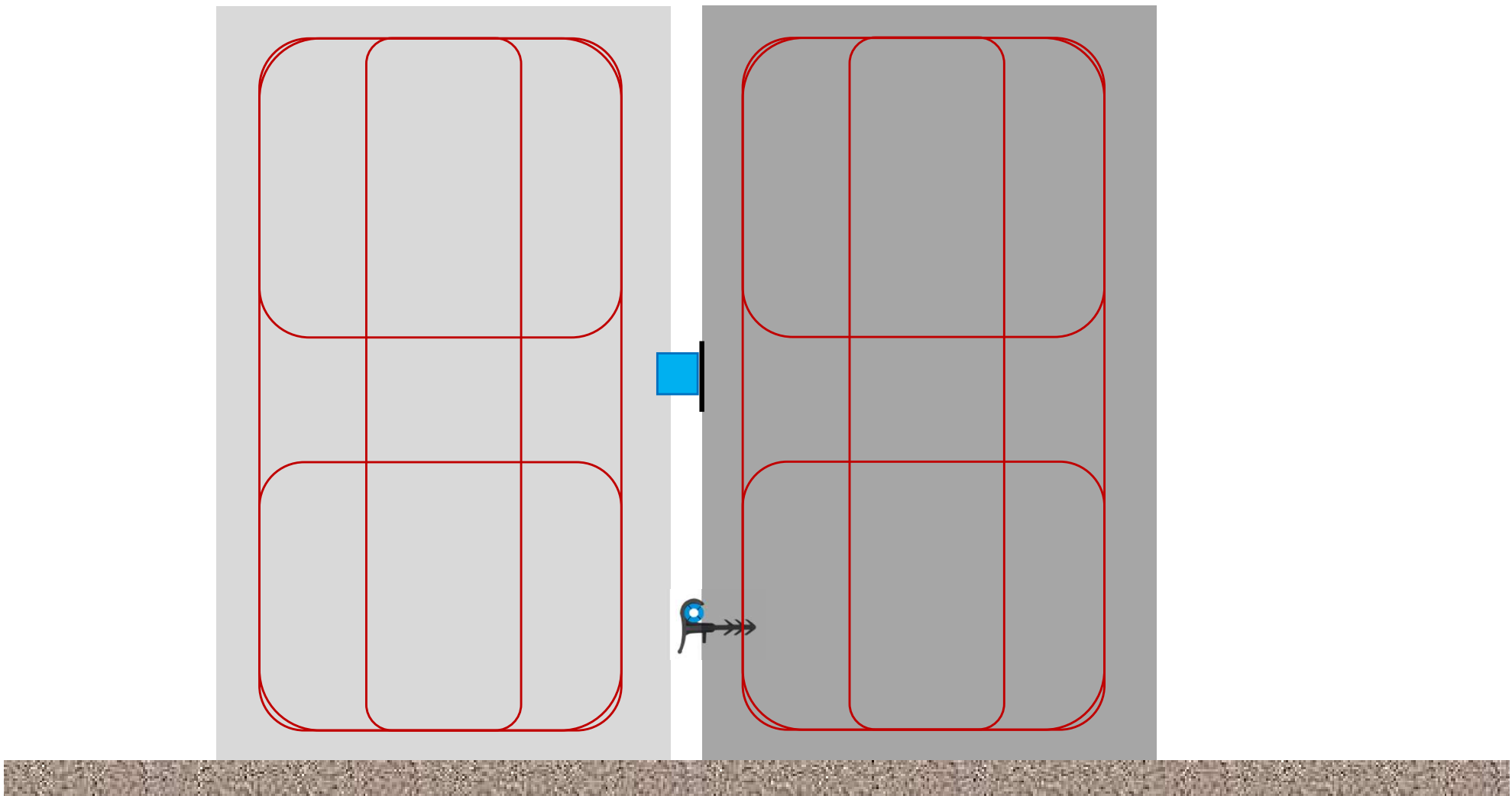

Dilatation Joint Sealing

Classical cross section

Removal of filler board and surface sealing with **Proofmate EK+ Flexible Resins**

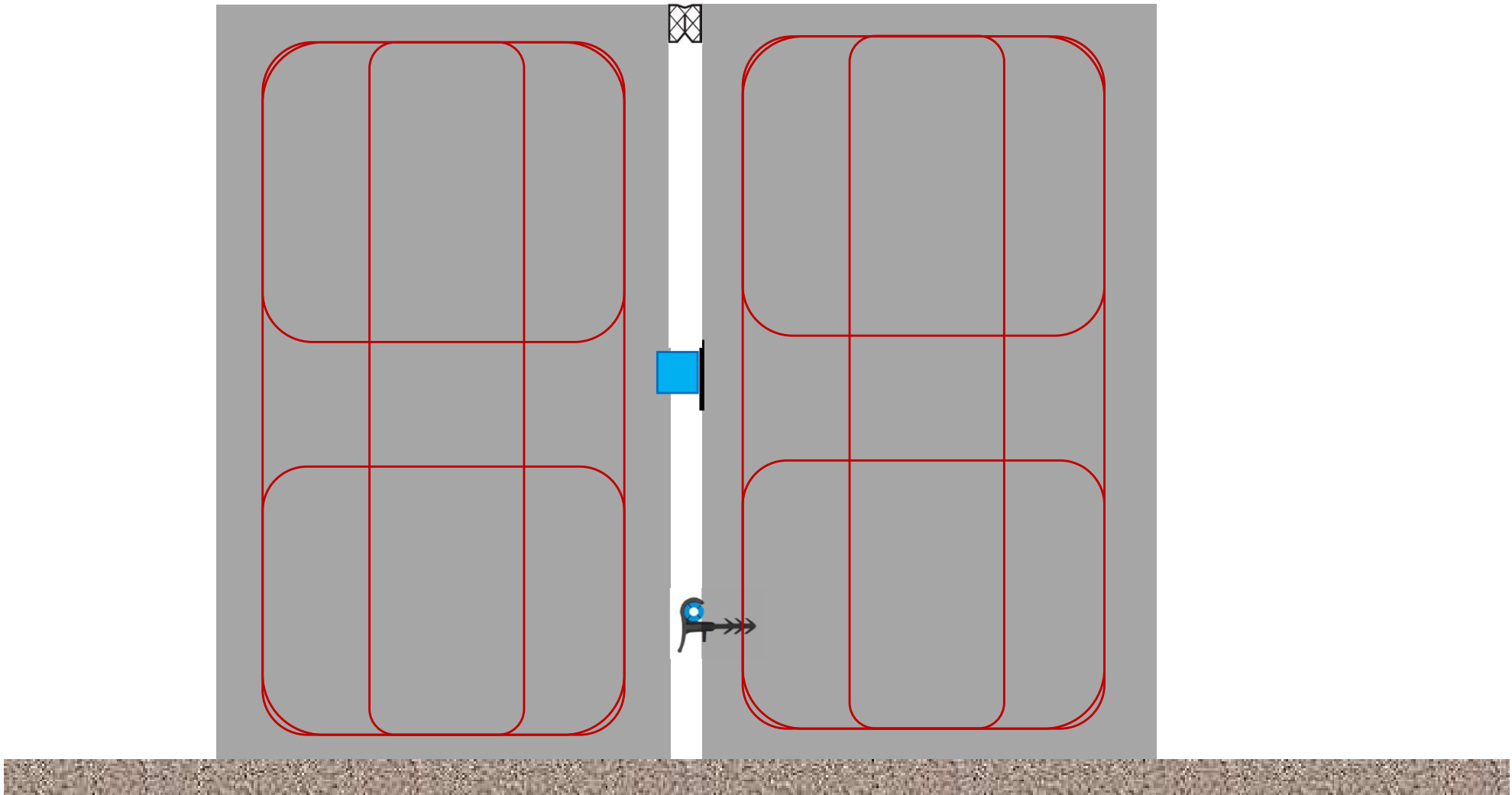

Dilatation Joint Sealing

Cross section - Alternative

Positioning of Formwork, reinforcement steel

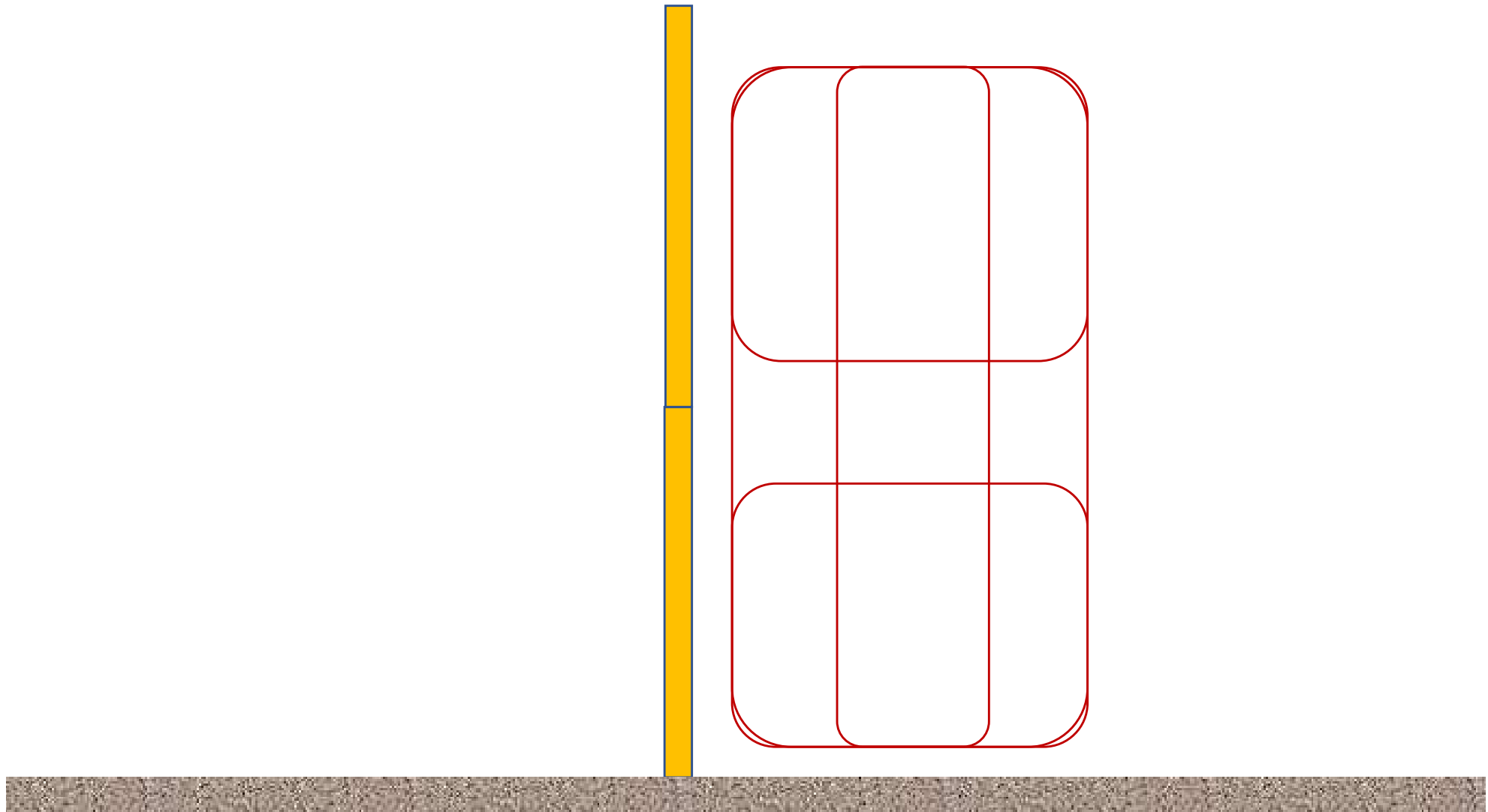

Dilatation Joint Sealing

Cross section - Alternative

1st concrete pour

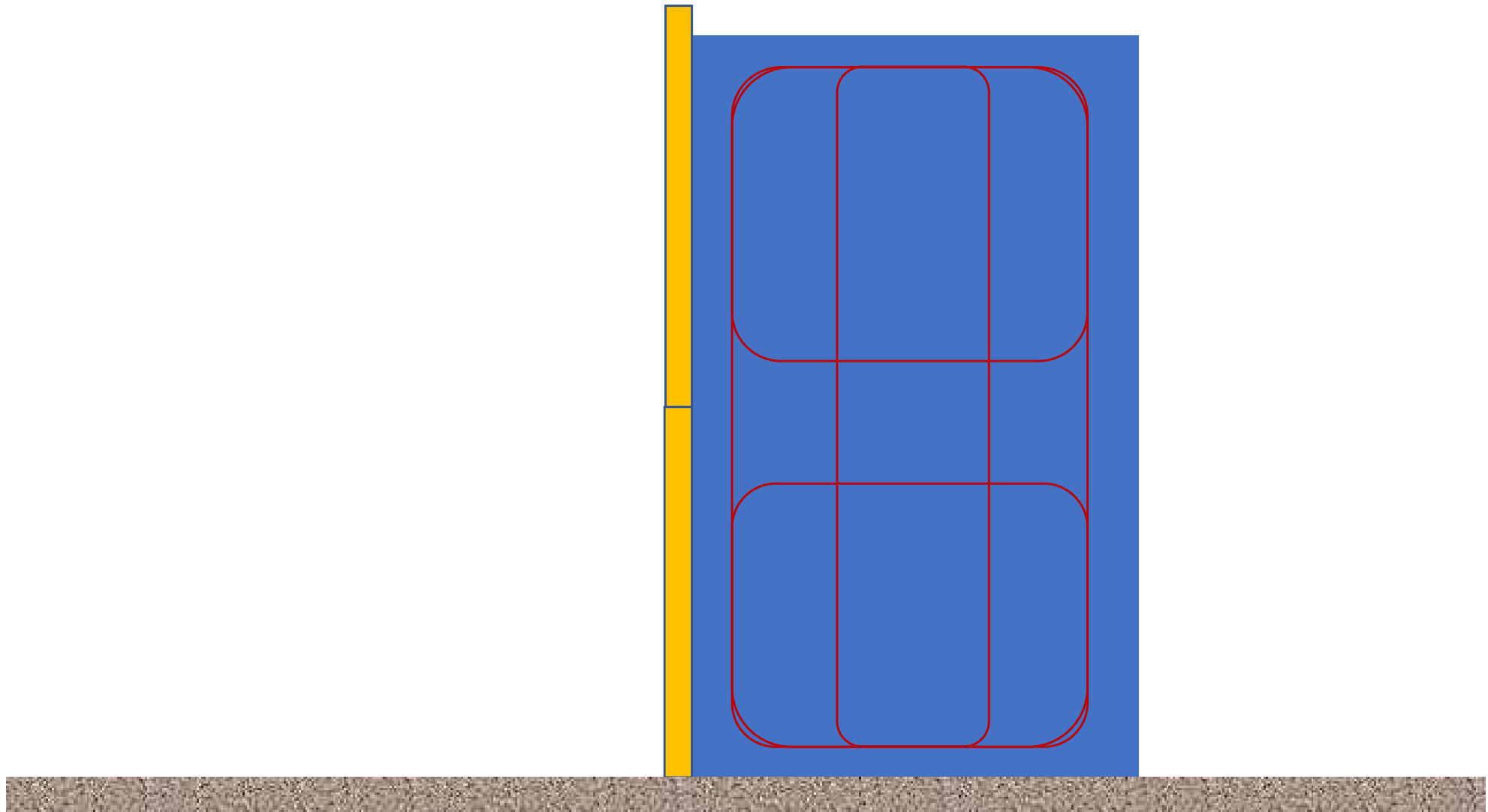

Dilatation Joint Sealing

Cross section - Alternative

Removal of formworks, positioning of Proofmate E + Flexible Resins and Injection hose VPress

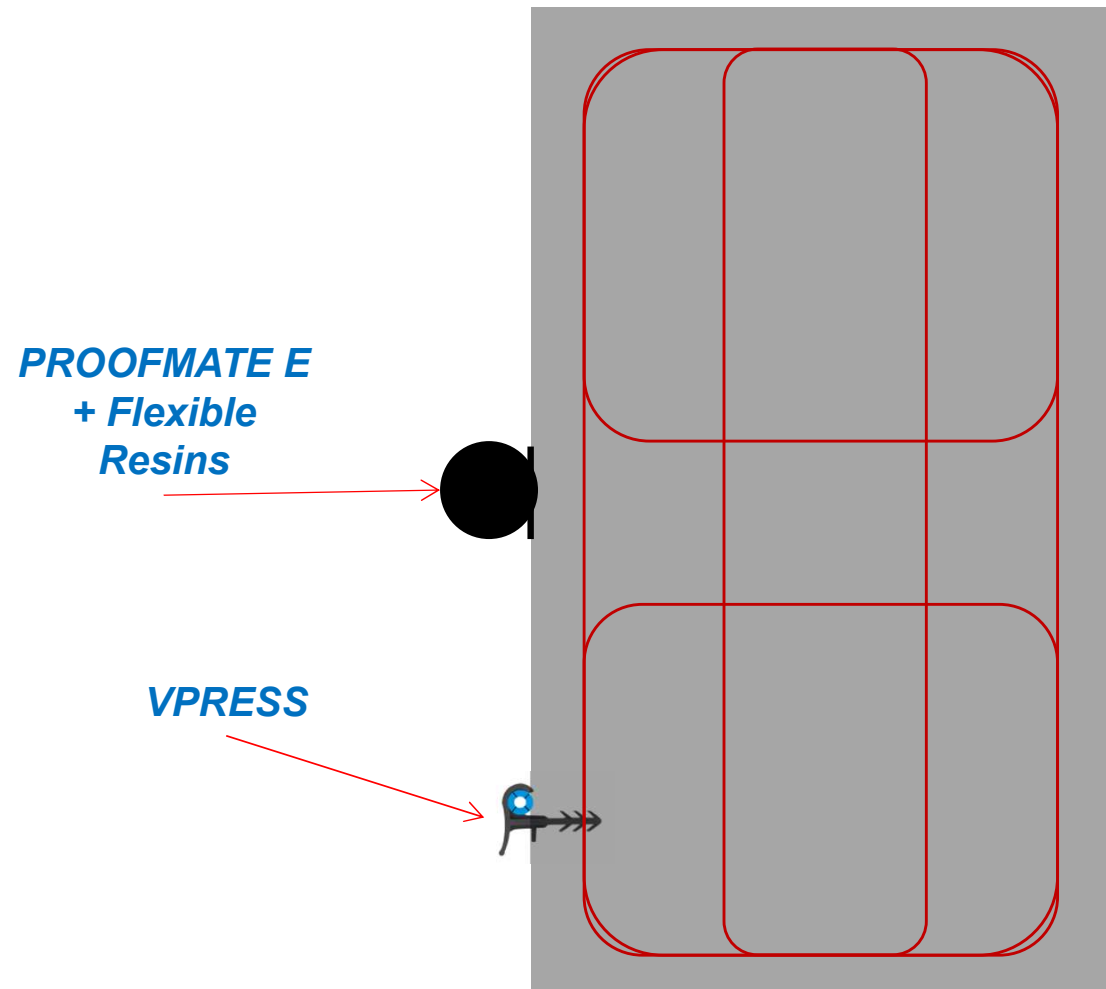

Dilatation Joint Sealing

Cross section - Alternative

Placement of filler board, reinforcement and successive pour

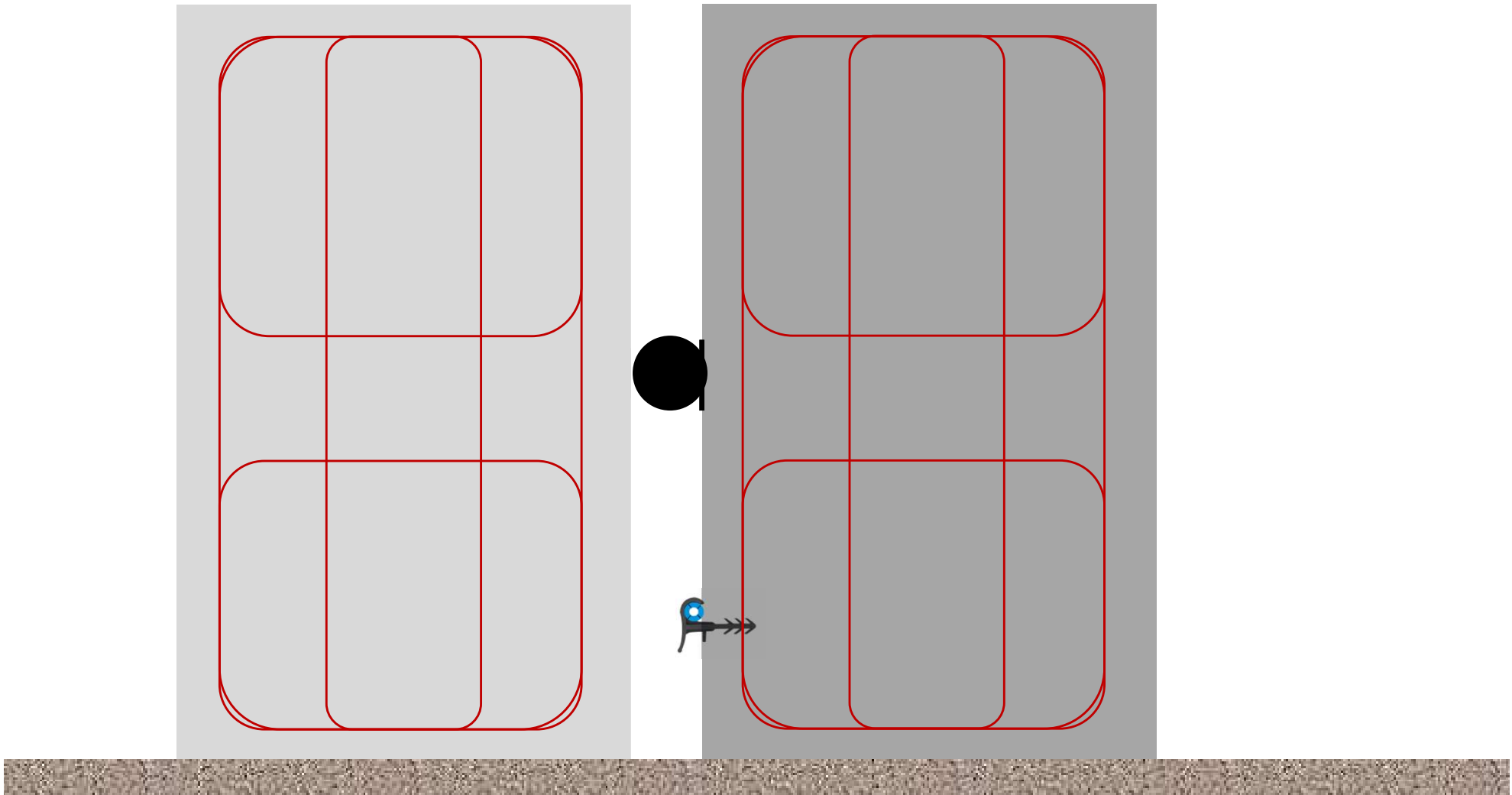

Dilatation Joint Sealing

Cross section - Alternative

Removal of filler board, Filling with VARIOTITE+POLINIT

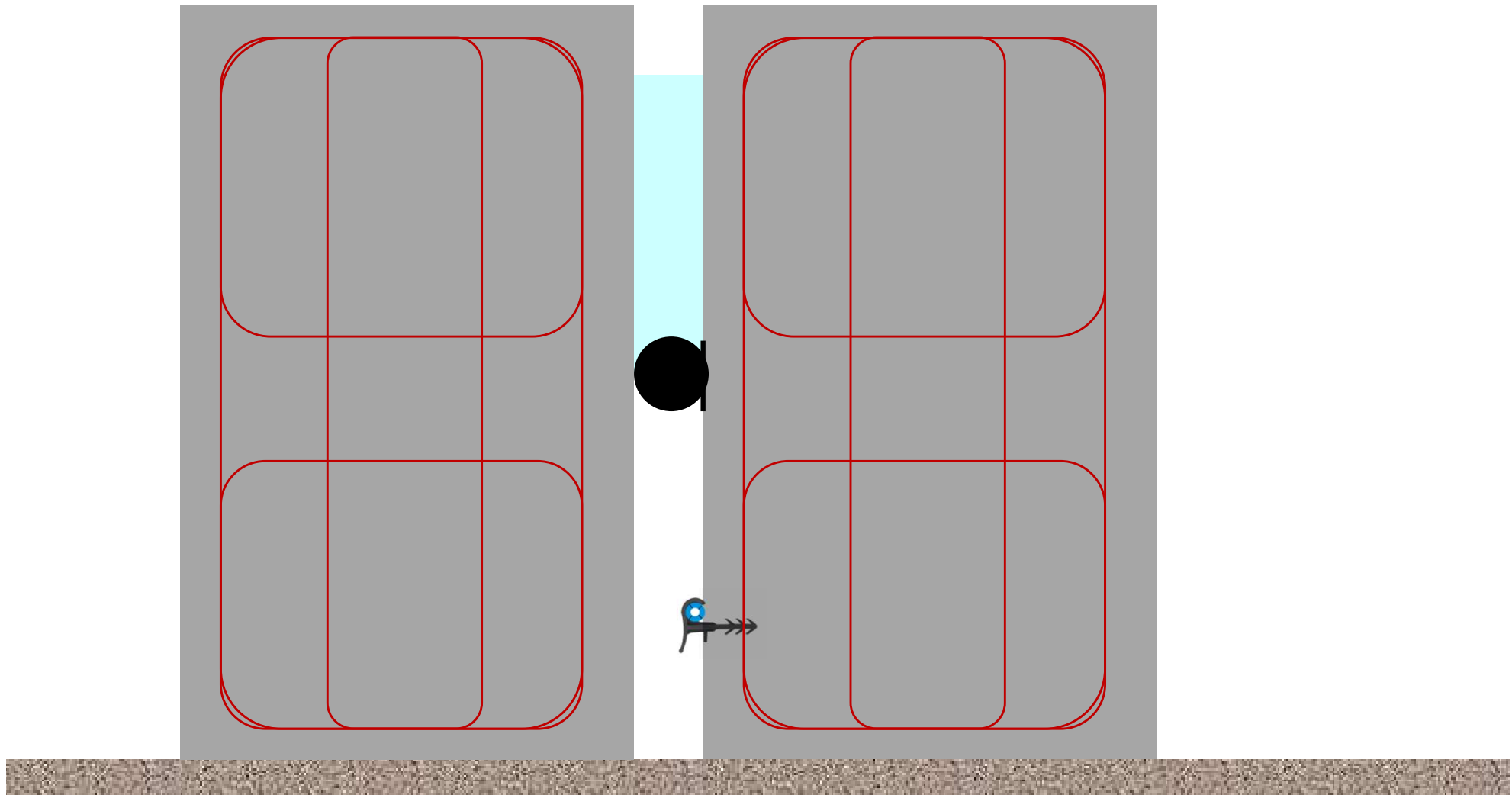

Dilatation Joint Sealing

Cross section

Eventual temporary water blocking pre-injection with **Polyurethane resins**

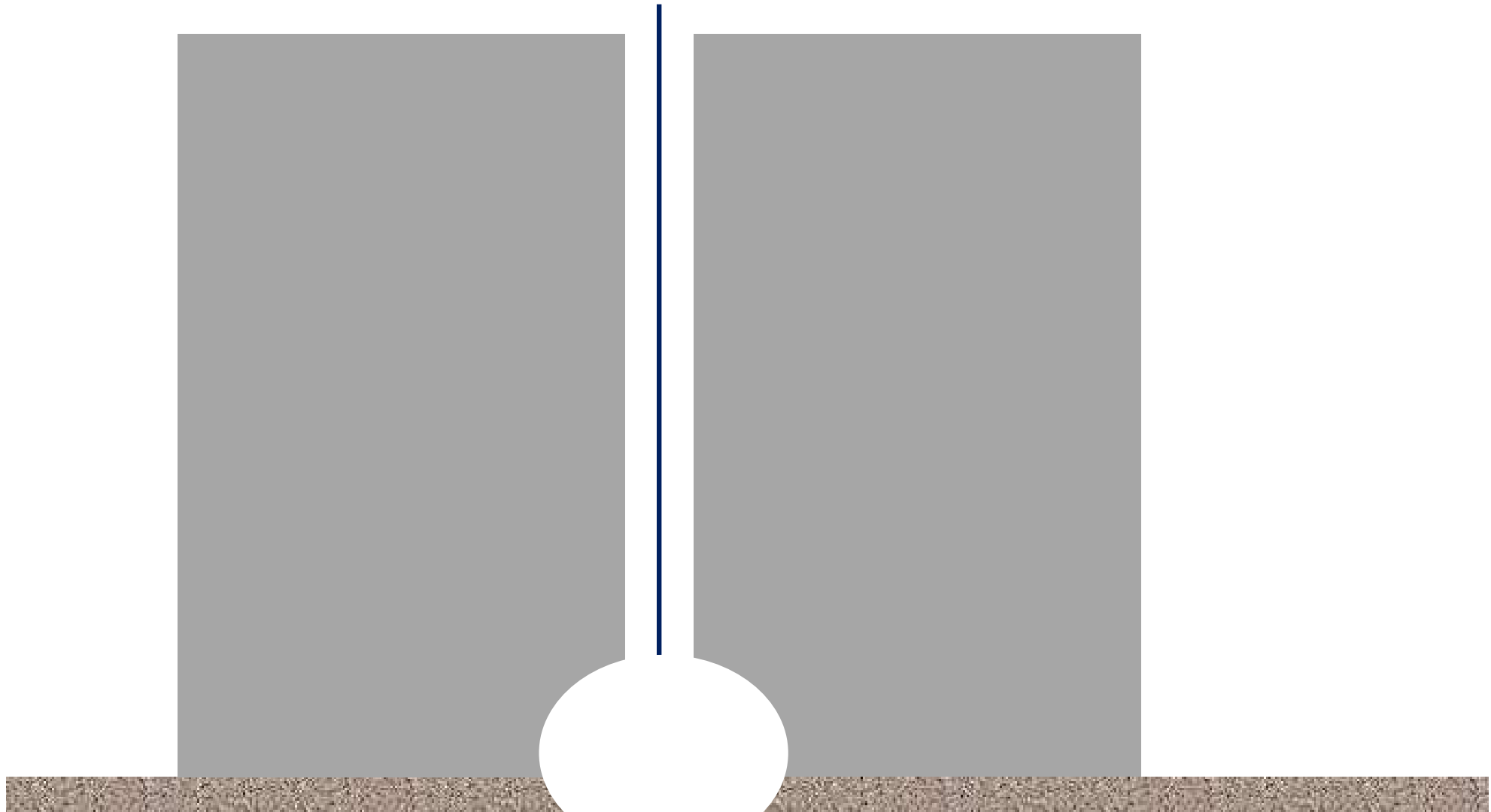

Dilatation Joint Sealing

Cross section

Cleaning and re-profiling with cements and resins

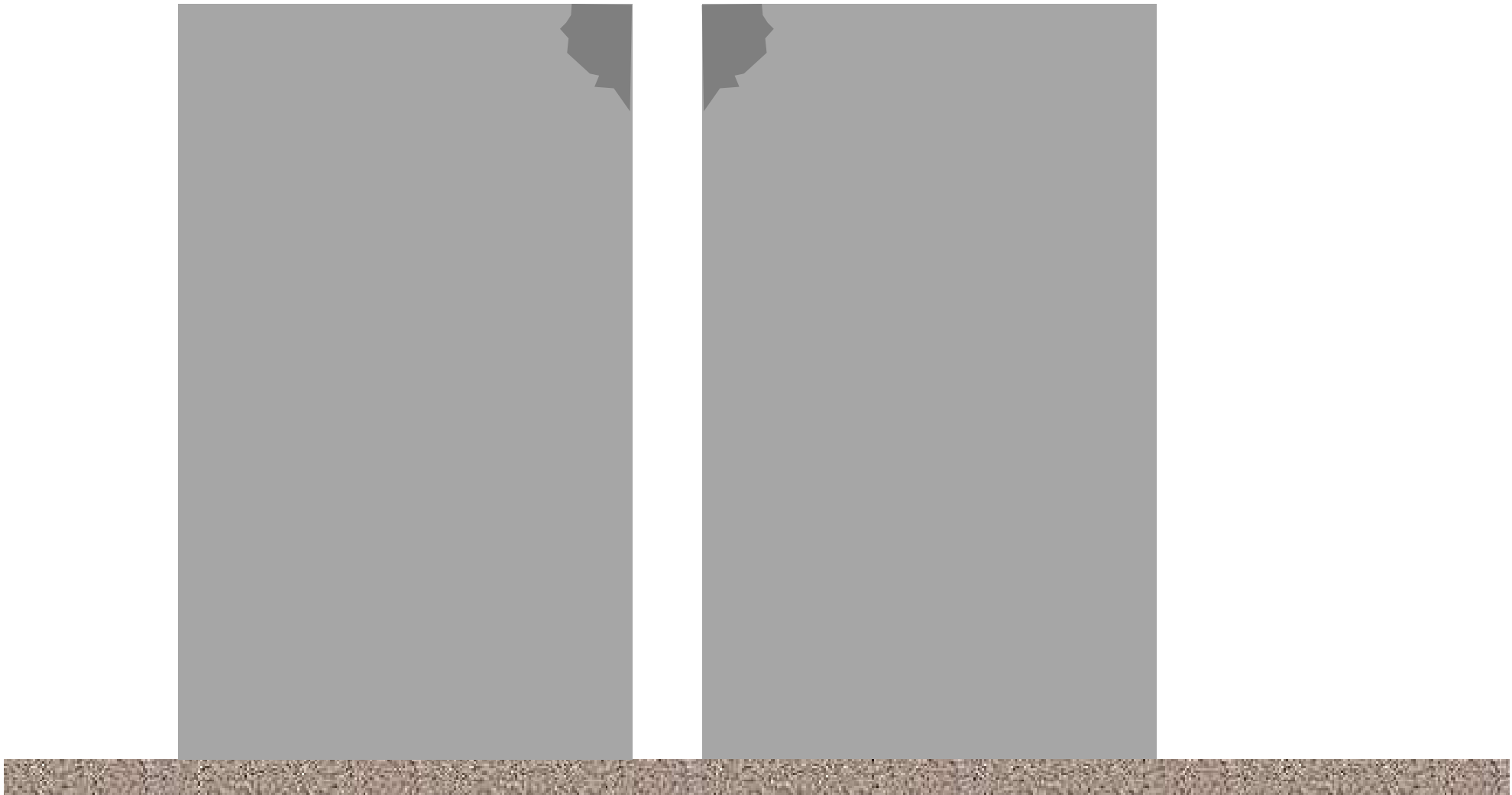

Dilatation Joint Sealing

Cross section

Placement of limiting knock-in Profile **Proofmate E**

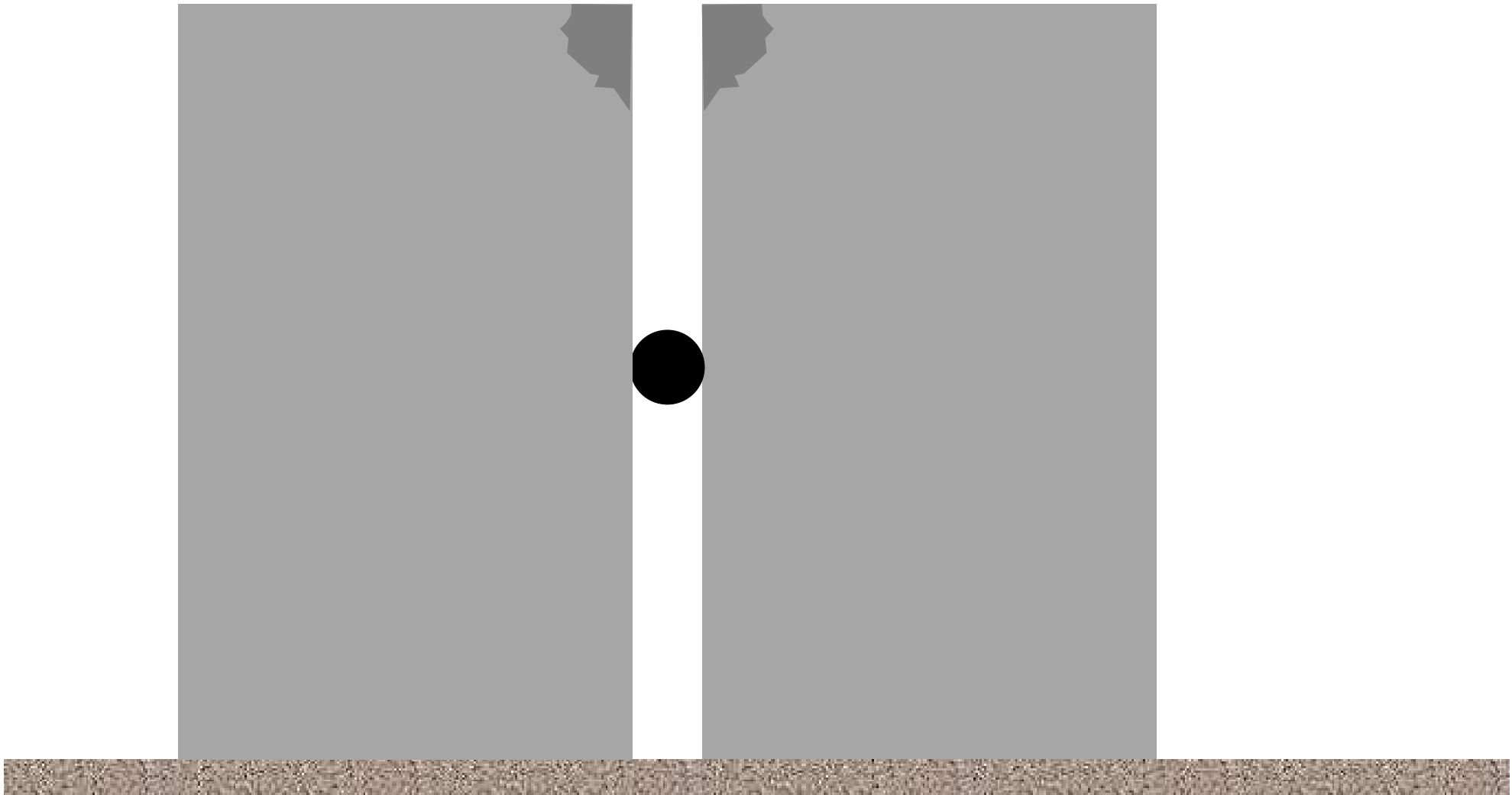

Dilatation Joint Sealing

Cross section

Placement of injection hose **VPRESS**

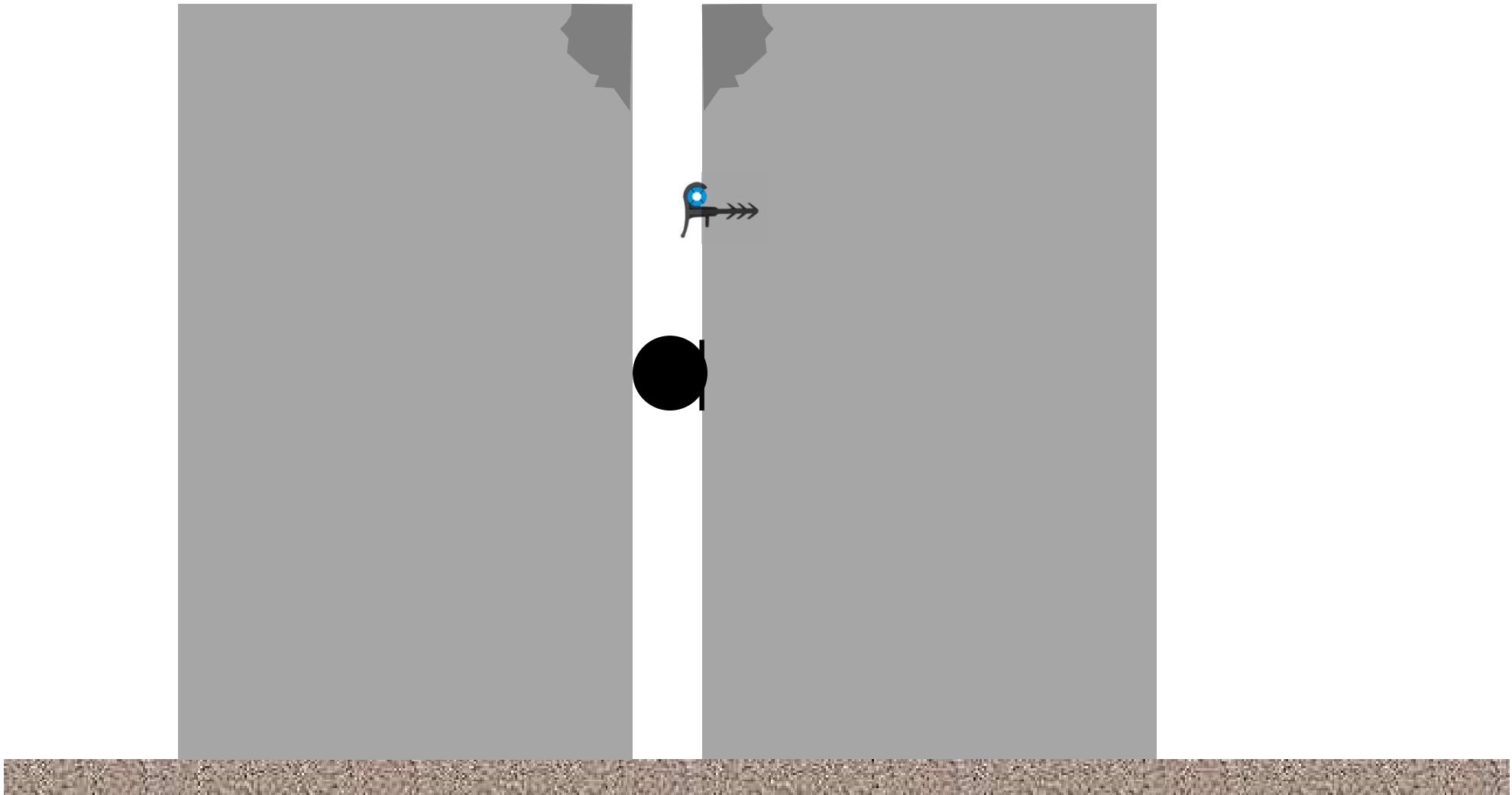

Dilatation Joint Sealing

Cross section

Surface sealing with **Proofmate EK+ Flexible resins**

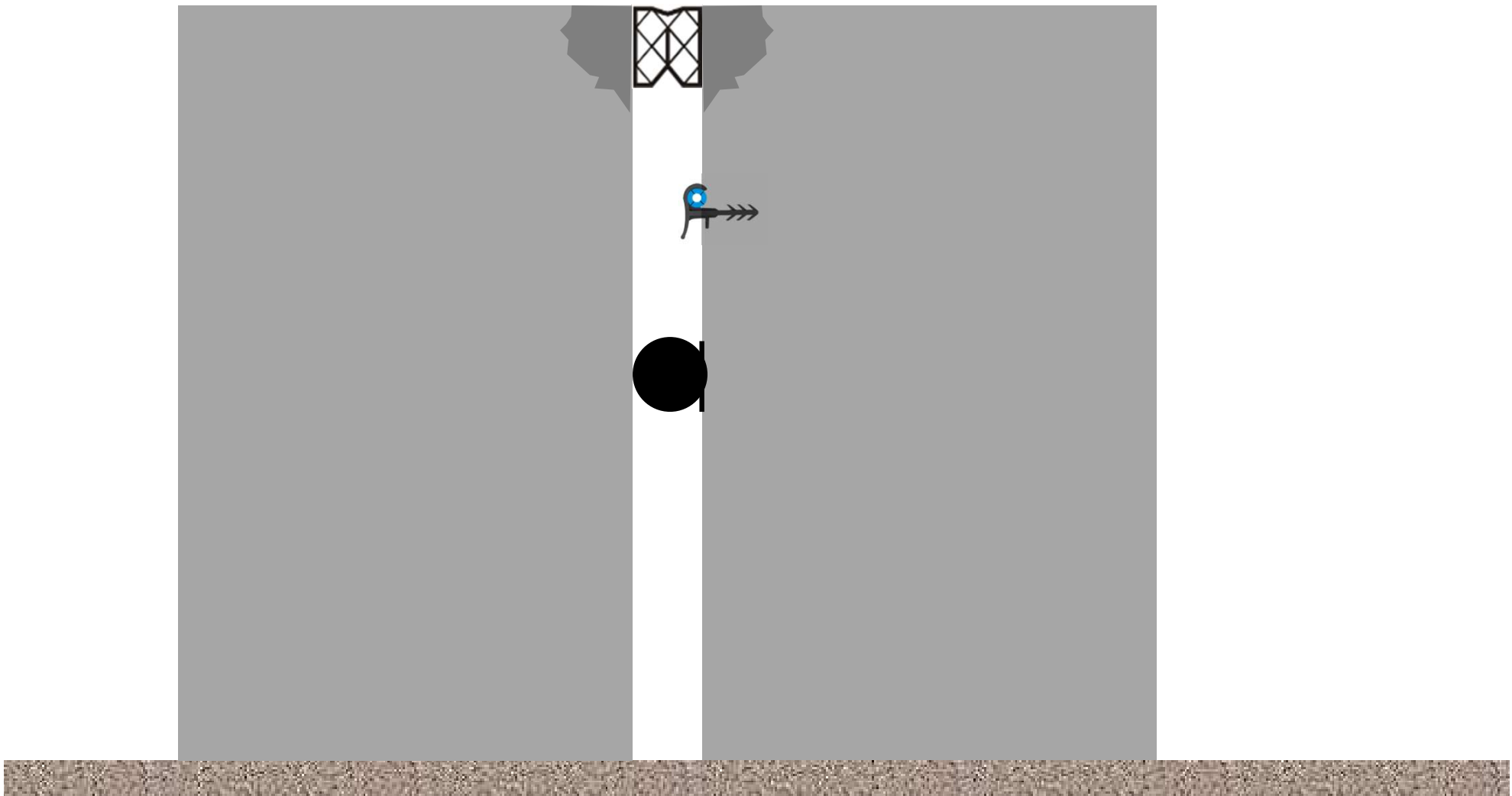

Dilatation Joint Sealing

Cross section

Eventual injection in between with **Flexible resins system via VPRESS**

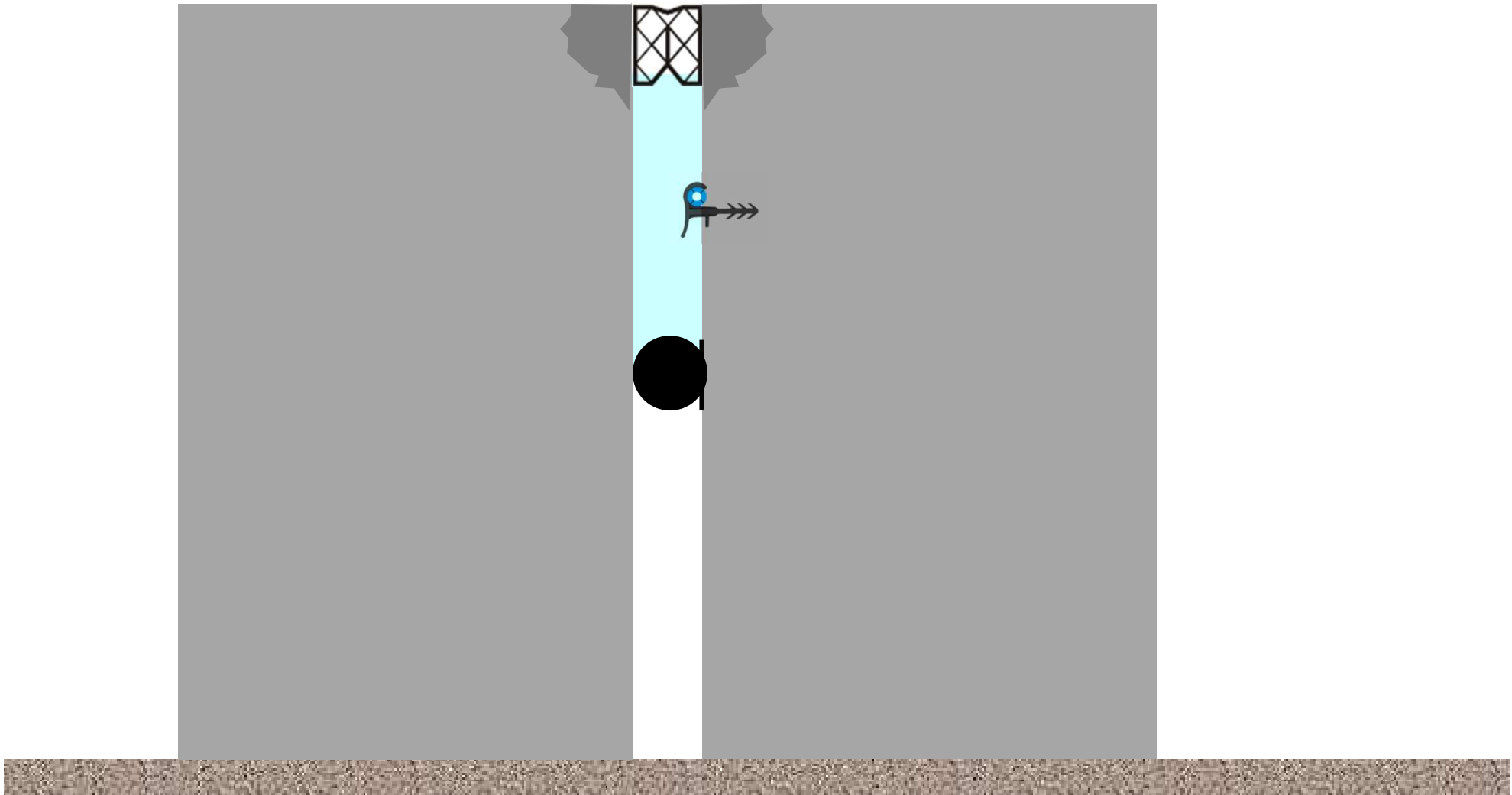

Working Joint Sealing

Classical Cross section

Positioning of PROOFMATE Waterstop PVC „AA“ Werksnorm and formwork

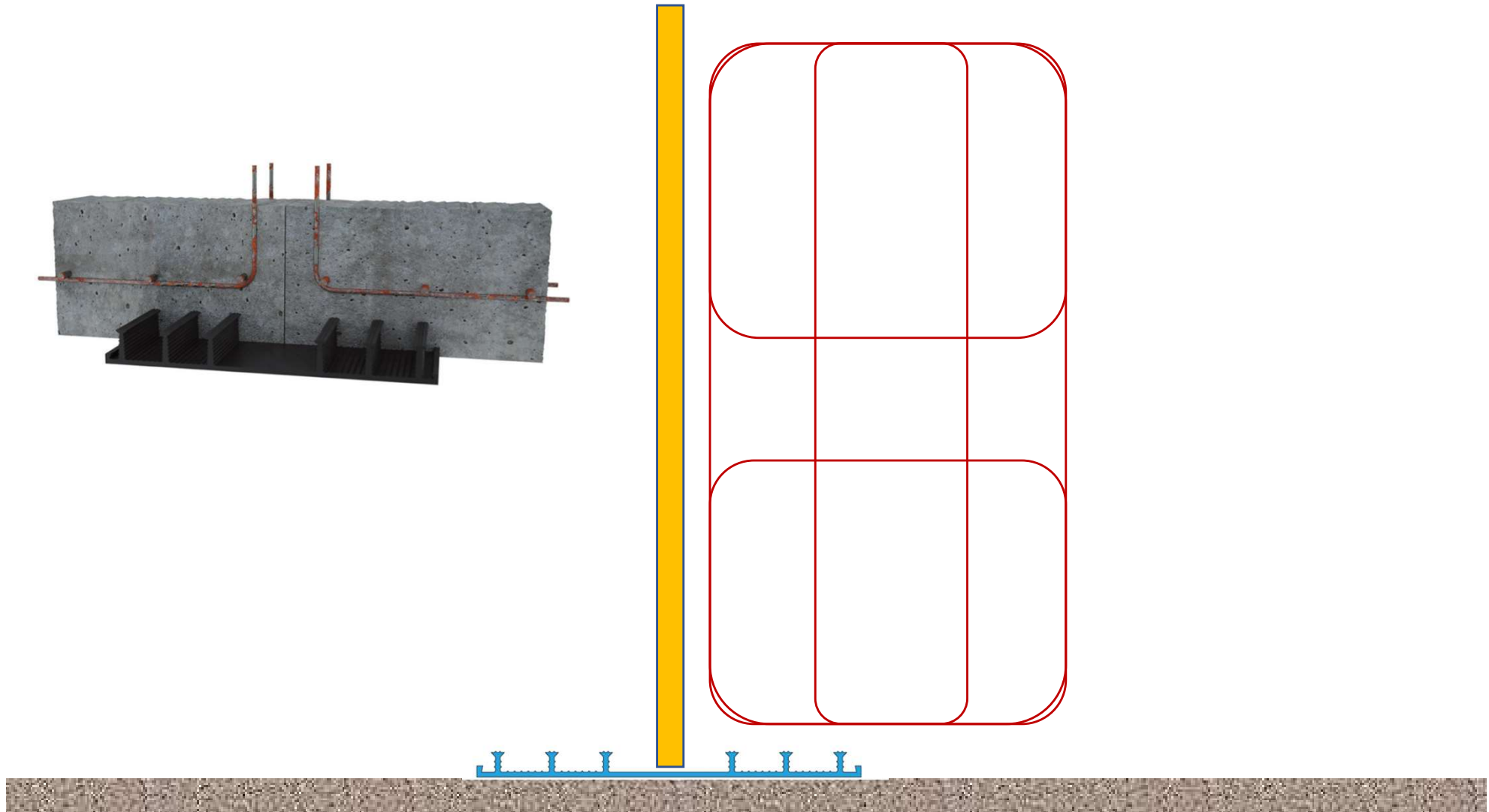

Working Joint Sealing

Classical Cross section

Pour of concrete

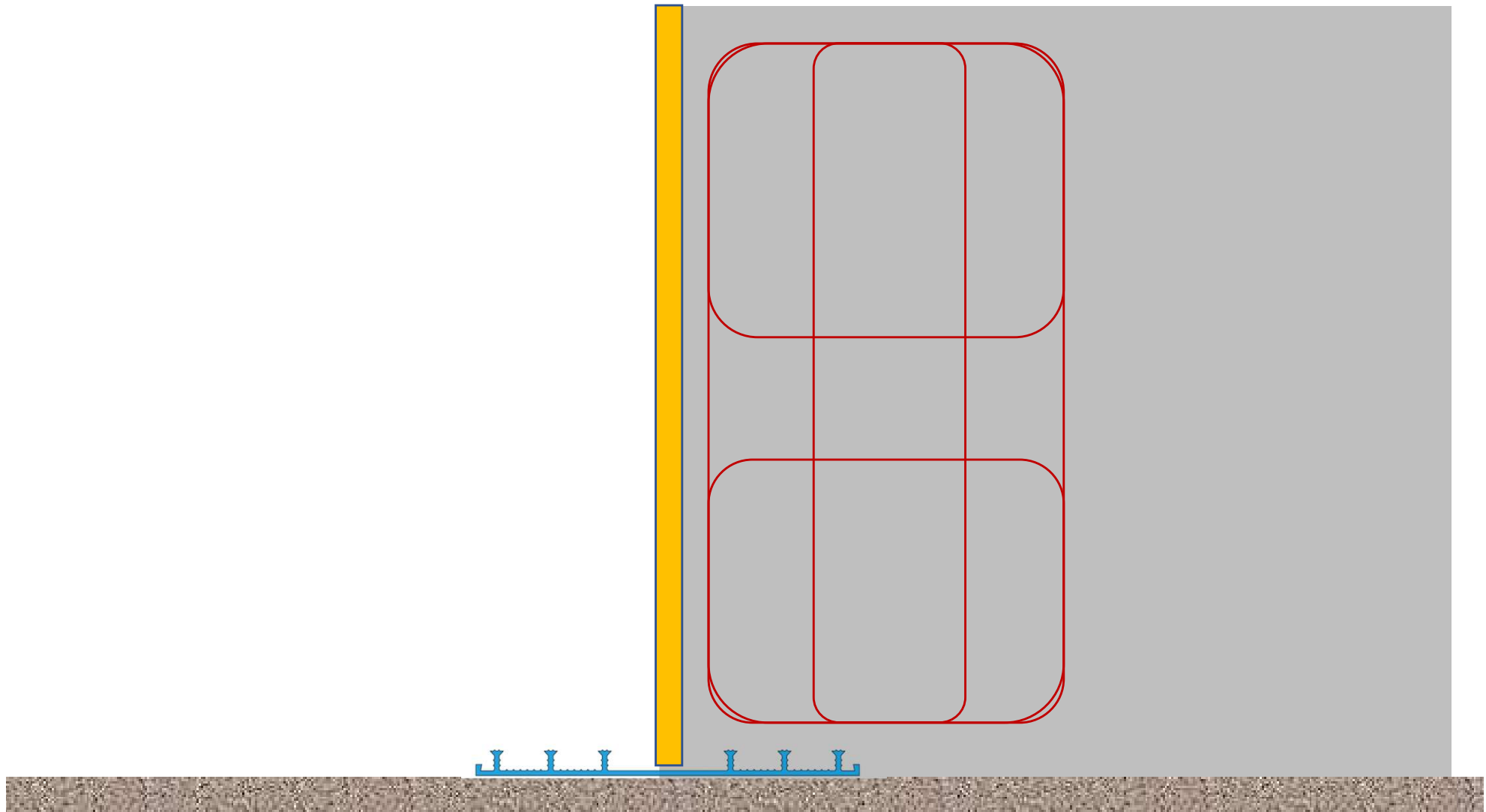

Working Joint Sealing

Classical Cross section

Removal of formwork, placement of reinforcement and successive pour

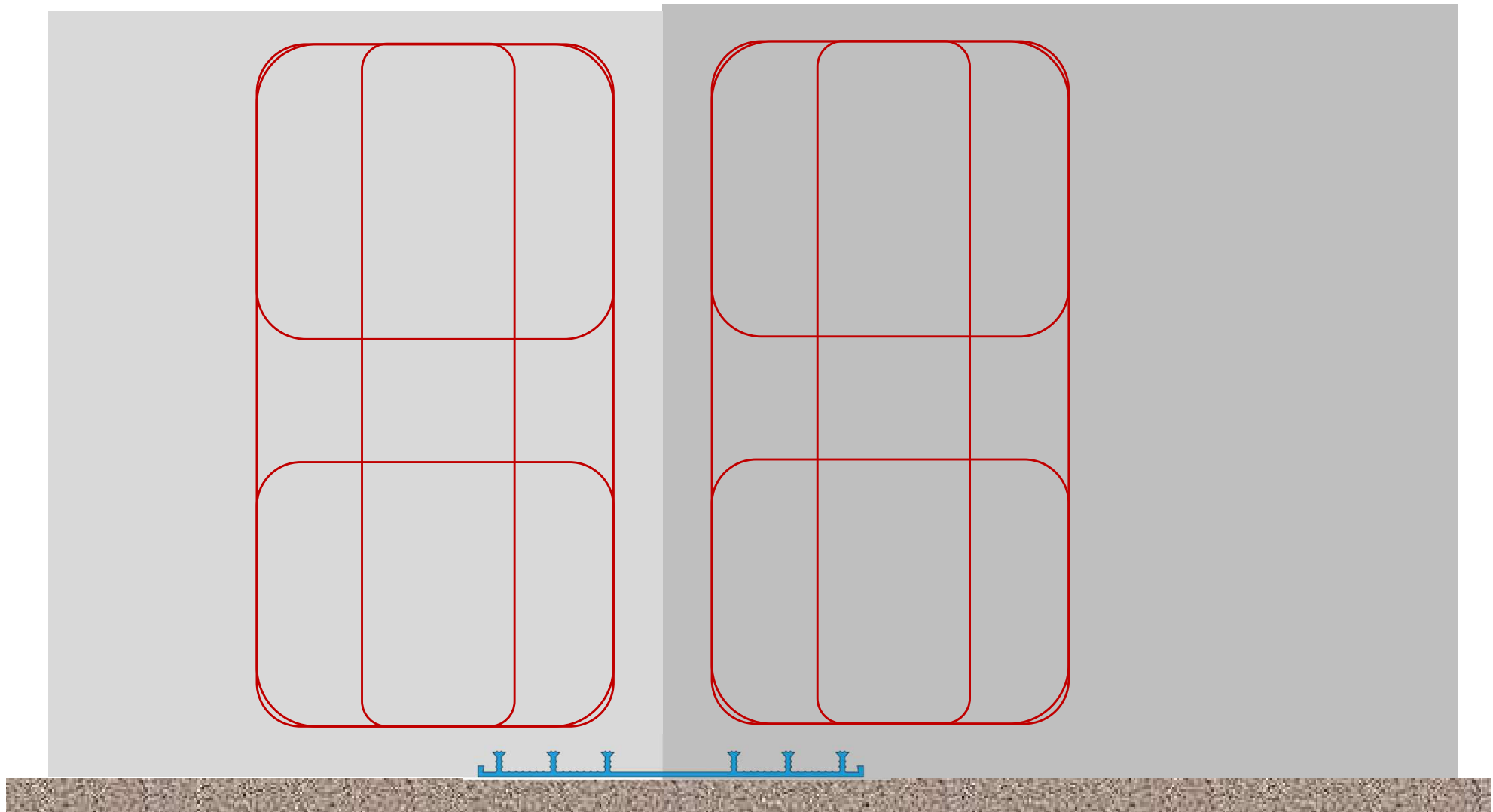

Working Joint Sealing

Classical Cross section

Positioning of formwork and pour of concrete

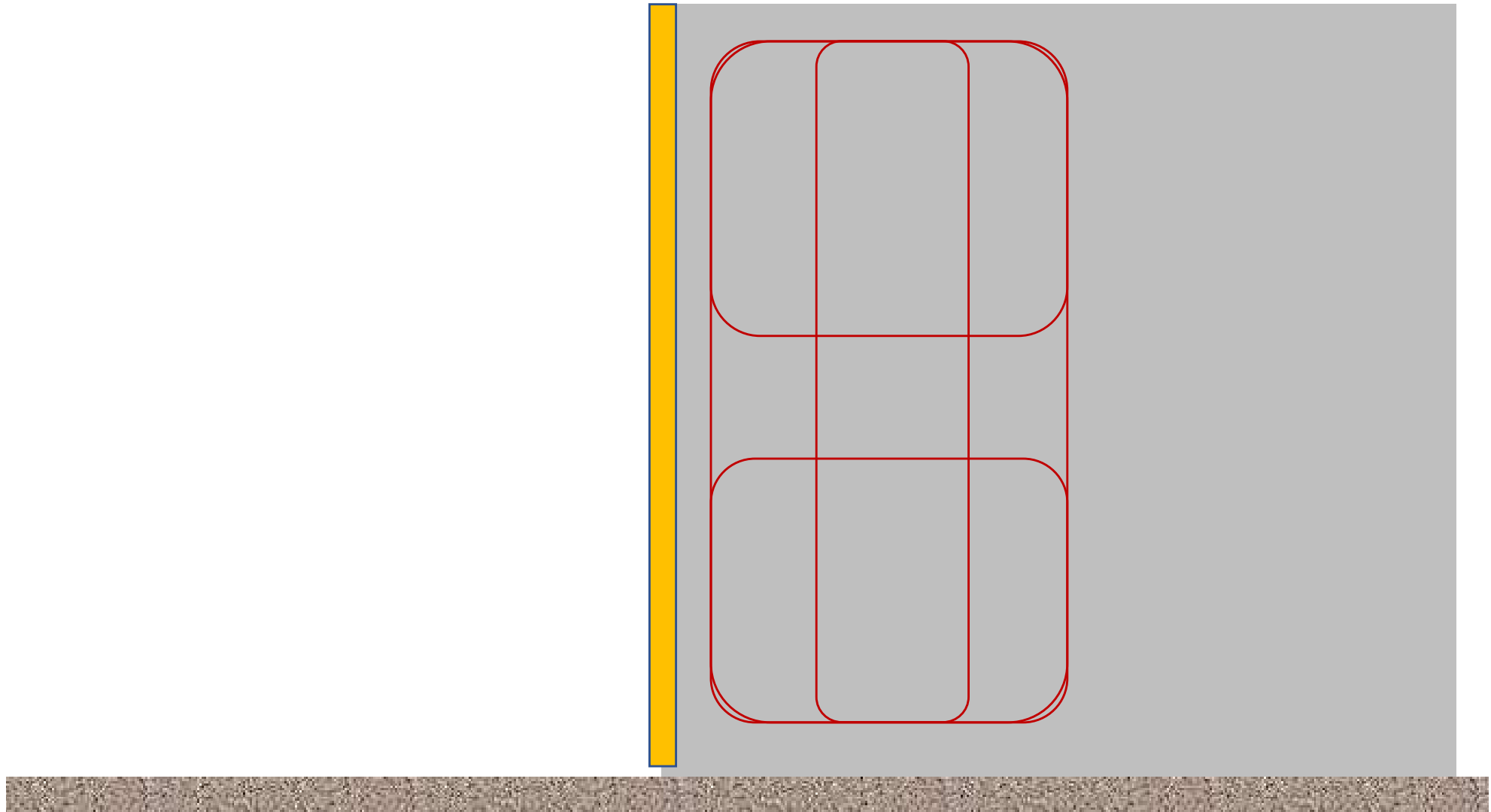

Working Joint Sealing

Classical Cross section

Placement of Hydrotite CJ profile with Quellflex

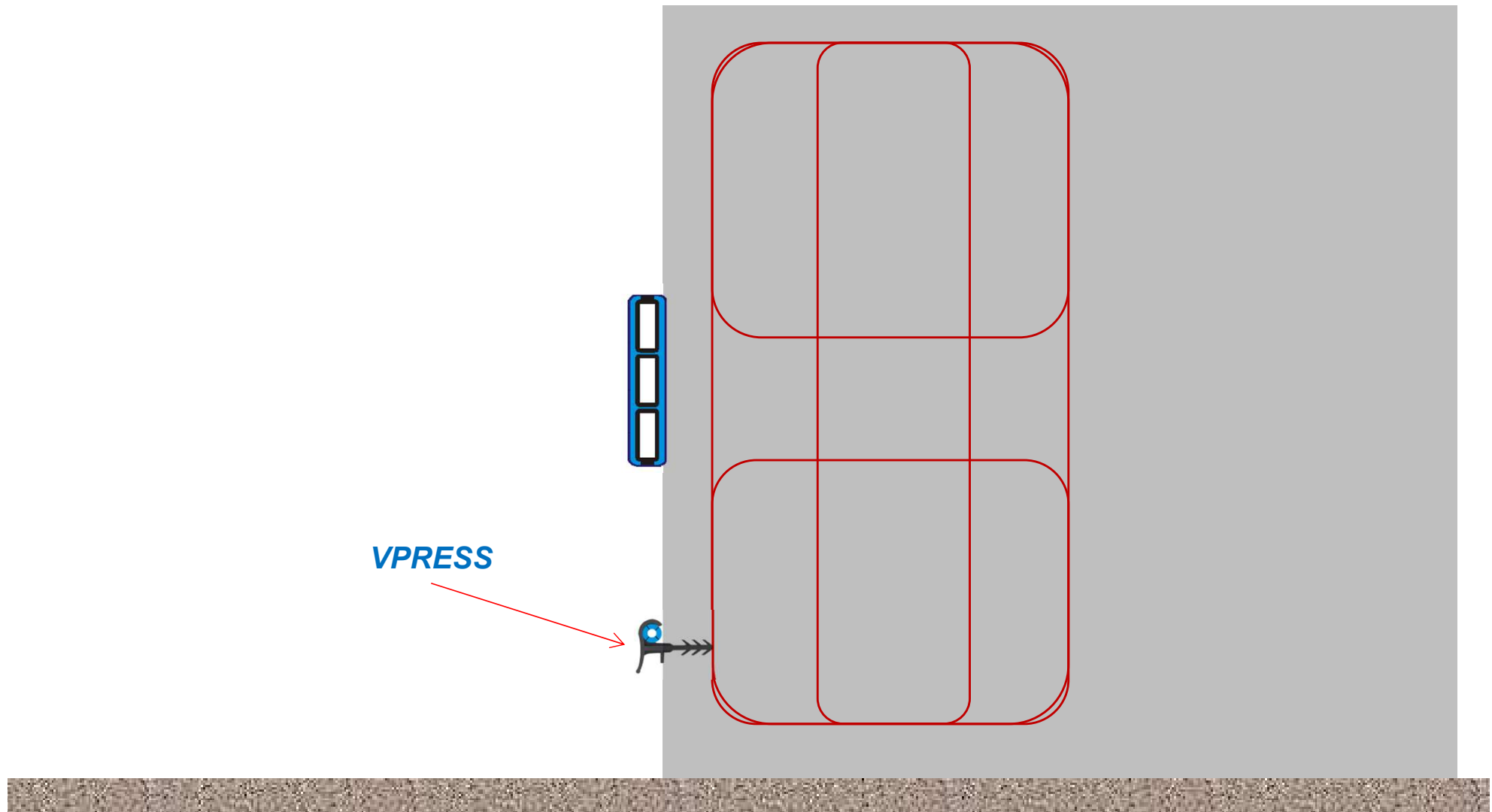

Working Joint Sealing

Classical Cross section

Second pour directly on the swelling profile

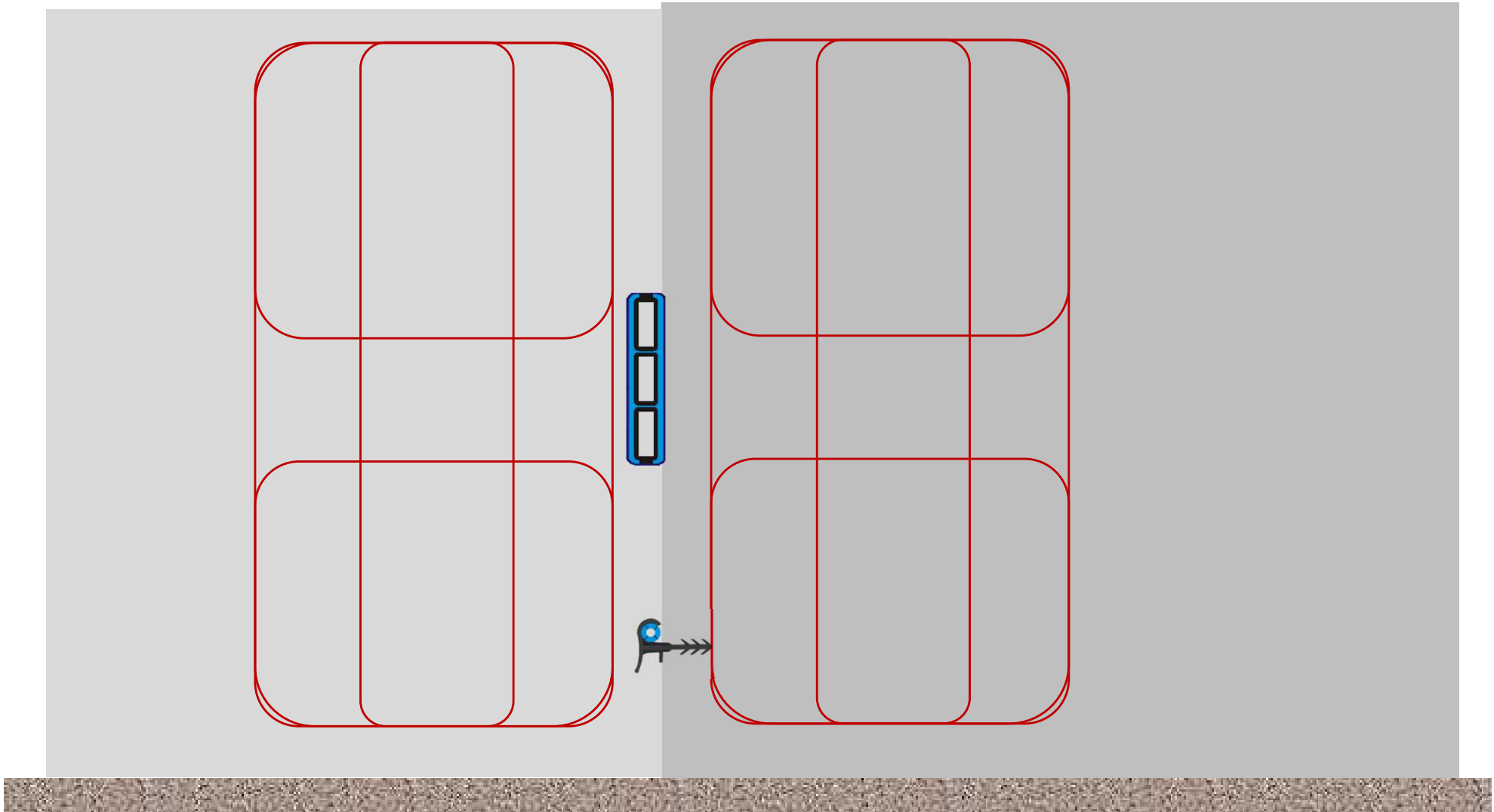

Working Joint Sealing

Classical Cross section

Positioning of formwork and pour of concrete

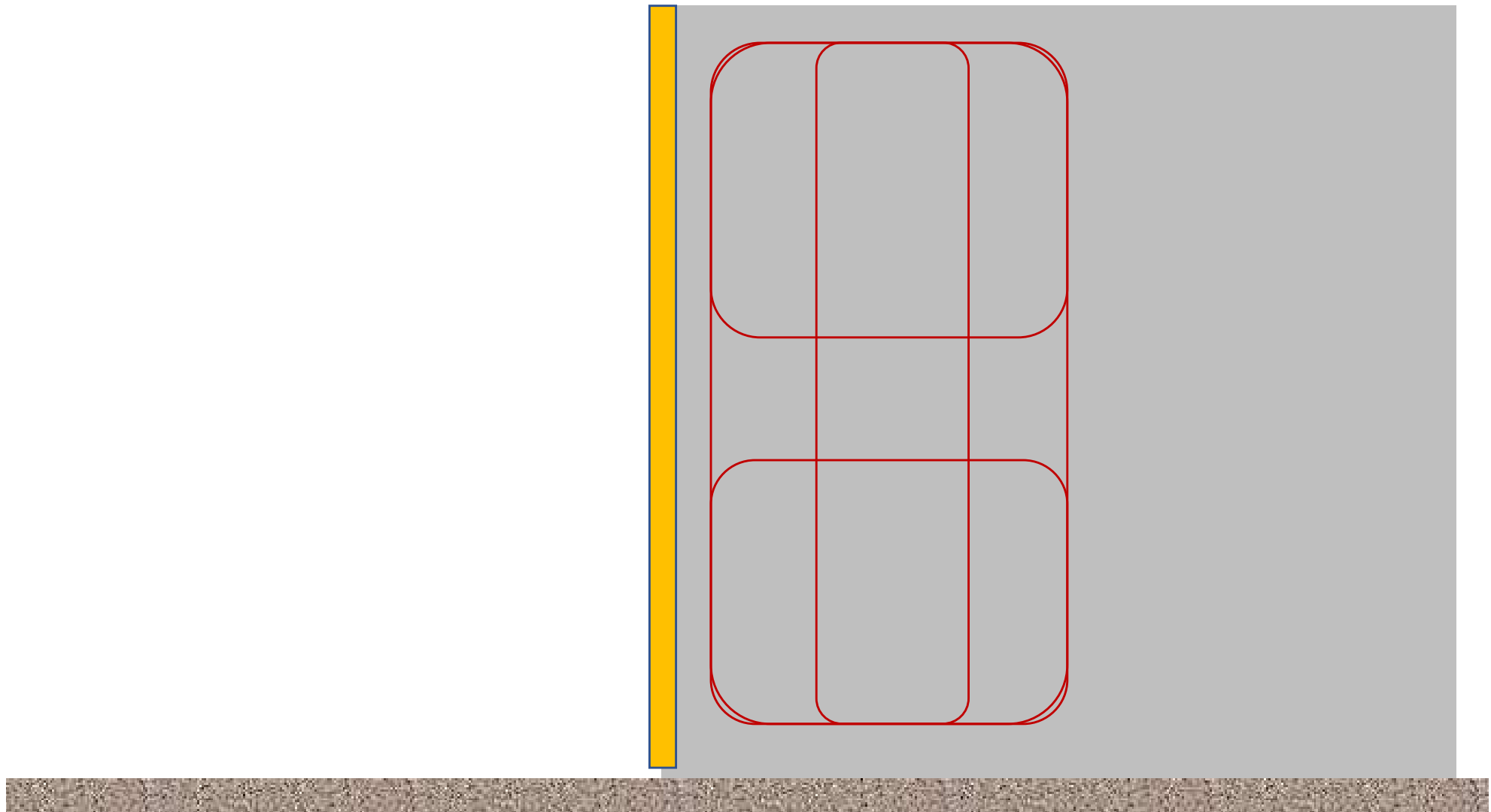

Working Joint Sealing - Cross section – Alternative 2

Second pour directly on the previous one

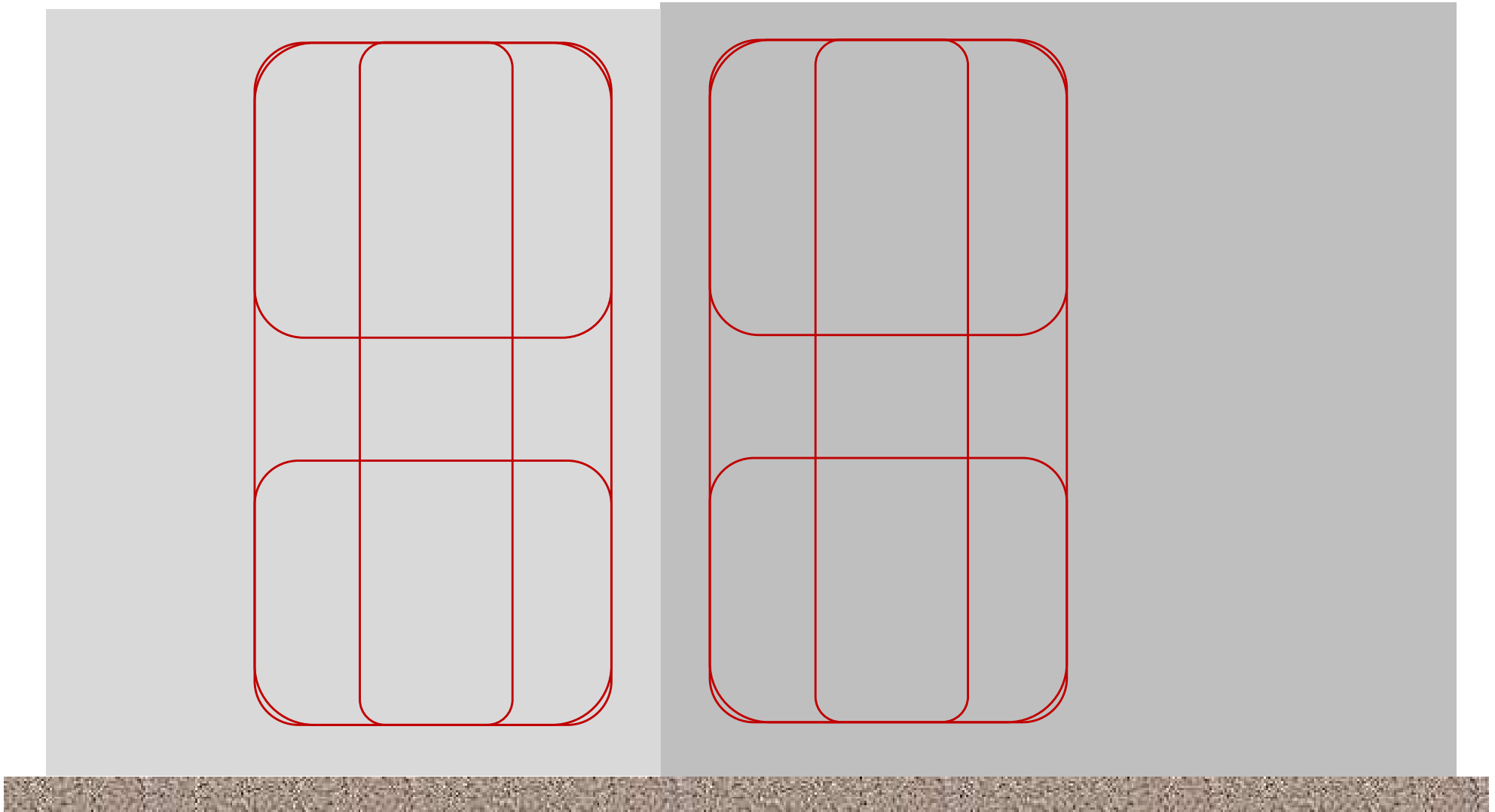

Working Joint Sealing

Classical Cross section - Alternative

Surface sealing with Proofmate Z Membrane and Proofmate F adhesive

